



Vegetable Slicer TRK45 Cutter Slicer - 4.5 LT - Variable Speed

ITEM # _____

MODEL # _____

NAME # _____

SIS # _____

AIA # _____

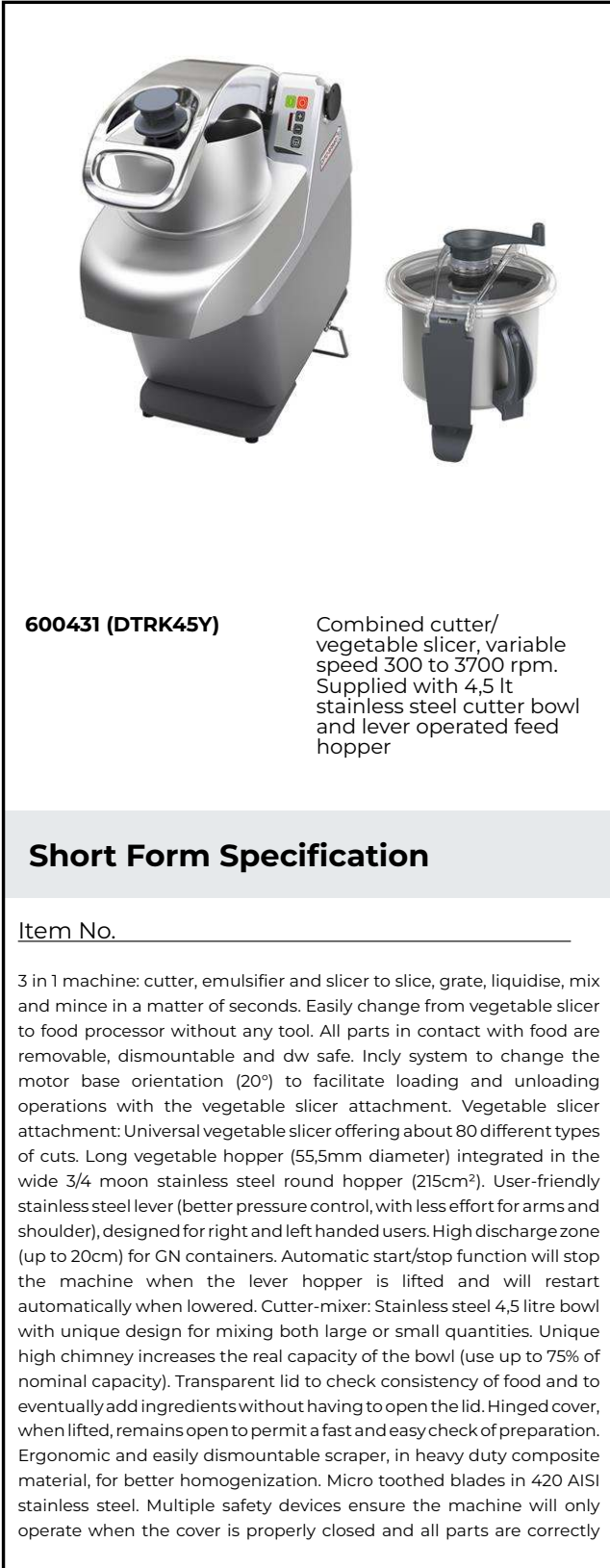

600431 (DTRK45Y)

Combined cutter/
vegetable slicer, variable
speed 300 to 3700 rpm.
Supplied with 4,5 lt
stainless steel cutter bowl
and lever operated feed
hopper

Short Form Specification

Item No. _____

3 in 1 machine: cutter, emulsifier and slicer to slice, grate, liquidise, mix and mince in a matter of seconds. Easily change from vegetable slicer to food processor without any tool. All parts in contact with food are removable, dismountable and dw safe. Incl system to change the motor base orientation (20°) to facilitate loading and unloading operations with the vegetable slicer attachment. Vegetable slicer attachment: Universal vegetable slicer offering about 80 different types of cuts. Long vegetable hopper (55,5mm diameter) integrated in the wide 3/4 moon stainless steel round hopper (215cm²). User-friendly stainless steel lever (better pressure control, with less effort for arms and shoulder), designed for right and left handed users. High discharge zone (up to 20cm) for GN containers. Automatic start/stop function will stop the machine when the lever hopper is lifted and will restart automatically when lowered. Cutter-mixer: Stainless steel 4,5 litre bowl with unique design for mixing both large or small quantities. Unique high chimney increases the real capacity of the bowl (use up to 75% of nominal capacity). Transparent lid to check consistency of food and to eventually add ingredients without having to open the lid. Hinged cover, when lifted, remains open to permit a fast and easy check of preparation. Ergonomic and easily dismountable scraper, in heavy duty composite material, for better homogenization. Micro toothed blades in 420 AISI stainless steel. Multiple safety devices ensure the machine will only operate when the cover is properly closed and all parts are correctly

APPROVAL: _____

positioned. Asynchronous industrial motor for heavy duty and longer life. Flat and waterproof control panel with on/off button, pulse function and variable speed (from 300 to 3700rpm).

TRK45 Cutter Slicer - 4.5 LT - Variable Speed
Vegetable Slicer



Vegetable Slicer TRK45 Cutter Slicer - 4.5 LT - Variable Speed

Main Features

- 3 in 1 machine: cutter, emulsifier and vegetable slicer to slice, grate, liquidise, mix and mince in a matter of seconds.
- Incl system to incline motor base at 20° to better fit the vegetable slicer attachment.
- Delivered with:
 - Stainless steel lever operated feed hopper
 - 4,5 lt stainless steel cutter bowl, transparent lid, scraper and microtoothed blade rotor
- Vegetable slicer with slicing, grating, shredding (julienne) as well as dicing and French fries cutting capability.
- Long vegetables round hopper integrated in the feed arm, 3/4 moon roundish hopper to limit pre cutting operations.
- Emulsifier function (scraper) included as standard.
- Base fixed cover for a better handling.
- Pulse function for coarse chopping.
- All parts in contact with food are removable without the use of tools, completely dismountable and dishwasher safe.
- Automatic restart of the machine with the 3/4 moon shaped pusher in position.
- Magnetic safety system and motor brake. Prevents machine from running when vegetable preparation lever and/or hopper are lifted or when cutter lid is not properly closed.
- Automatic speed limitation according to the selected function (slicer or cutter).
- Complete and wide selection of blades and grids available (diam. 205 mm).
- Capacity:
 - vegetable slicer productivity 550 kg/h, suitable for 100-400 meals for table service, up to 800 meals for catering service
 - cutter mixer working capacity from 100 g to 2 kg, for 50-80 meals per service

Construction

- Asynchronous industrial motor with no brushes for high reliability and quiet functioning, stainless steel motor shaft.
- All blades (available on request) are made in stainless steel and dishwasher safe.
- Improved ventilation system to manage smoothly heavy duty use.
- Improved incl system for better stability.
- Improved fixing of long vegetable hopper pusher.
- Stainless steel bowl has a high chimney to ensure high productivity also when processing liquids.
- Feeding arm and hopper are made entirely in stainless steel. Aluminum motor housing.
- Vegetable cutting at 4 speeds up to 800 rpm. Food processing at 10 variable speeds: 300-3700 rpm.
- IP24 throughout entire machine.
- Power: 1.3 HP.
- IPX5 (IP55) waterproof, flat, touch-control panel.
- Compact and portable design.

Included Accessories

- 1 of Lid and bowl scraper for 4,5 lt PNC 650099 cutter mixer



Vegetable Slicer
TRK45 Cutter Slicer - 4.5 LT - Variable Speed

The company reserves the right to make modifications to the products without prior notice. All information correct at time of printing.

2024.12.21



Vegetable Slicer TRK45 Cutter Slicer - 4.5 LT - Variable Speed

Front

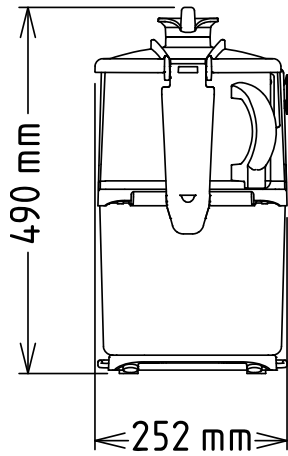

Electric

Supply voltage:

600431 (DTRK45Y) 200-240 V/1N ph/50/60 Hz

Electrical power max.: 1 kW

Total Watts: 1 kW

Capacity:

Performance (up to): 550 kg/hour

Capacity: 4.5 litres

Key Information:

External dimensions,

Width: 252 mm

External dimensions,

Depth: 485 mm

External dimensions,

Height: 505 mm

Shipping weight: 29 kg

Side

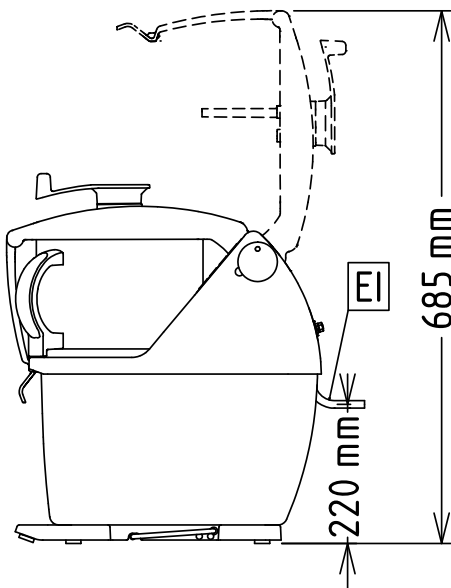

EI = Electrical inlet
(power)

Top

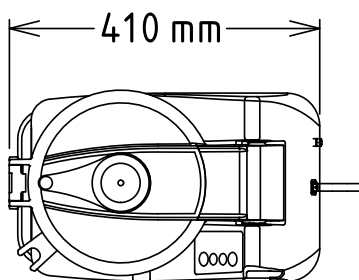

Vegetable Slicer
TRK45 Cutter Slicer - 4.5 LT - Variable Speed

The company reserves the right to make modifications to the products
without prior notice. All information correct at time of printing.

2024.12.21

